

KENMORE

INSTRUCTIONS

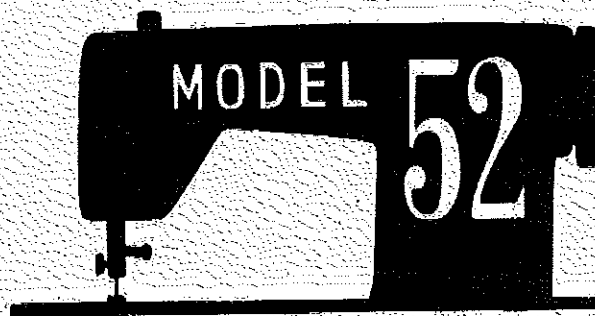

AUTOMATIC ZIG-ZAG SEWING MACHINE

**TABLE OF
CONTENTS**

Adjusting for Good Stitches	32	Needle & Thread Table	5
Adjusting Pressure of Presser Foot	10	Needle Size	5
Adjusting Tensions	12-13	Overcasting	23
Applique	22	Parts List	33
Automatic Decorating Stitches	17	Picking up Bobbin Thread	10
Basting	11	Placement of Needle	5
Blind Stitching	19	Removing Bobbin Case from Shuttle	6
Buttonholes	20-21	Reverse Stitching	11
Buttons	19	Replacement of Belt	27
Changing the Presser Foot	15	Setting Stitch Length	11
Cleaning & Oiling	27-28	Setting Stitch Width	16
Connecting Machine	4	Sewing Light	4
Darning	18	Sewing on Buttons	19
Double Needle	24-25	Sewing on Lace	22
Fastening a Seam	11	Sewing on Plastic Films	28
Feed Dog Control	15	Synthetics	28
Identification Head Parts	2-3	Threading Upper Machine	9
Inserting Bobbin into Bobbin Case	8	Turning a Corner	15
Inserting Disc	16	What to Do	30-31
Inserting & Removing Material	14	Winding the Bobbin	7
Installing Machine Head	4	Writing & Monogramming	23

FRONT VIEW

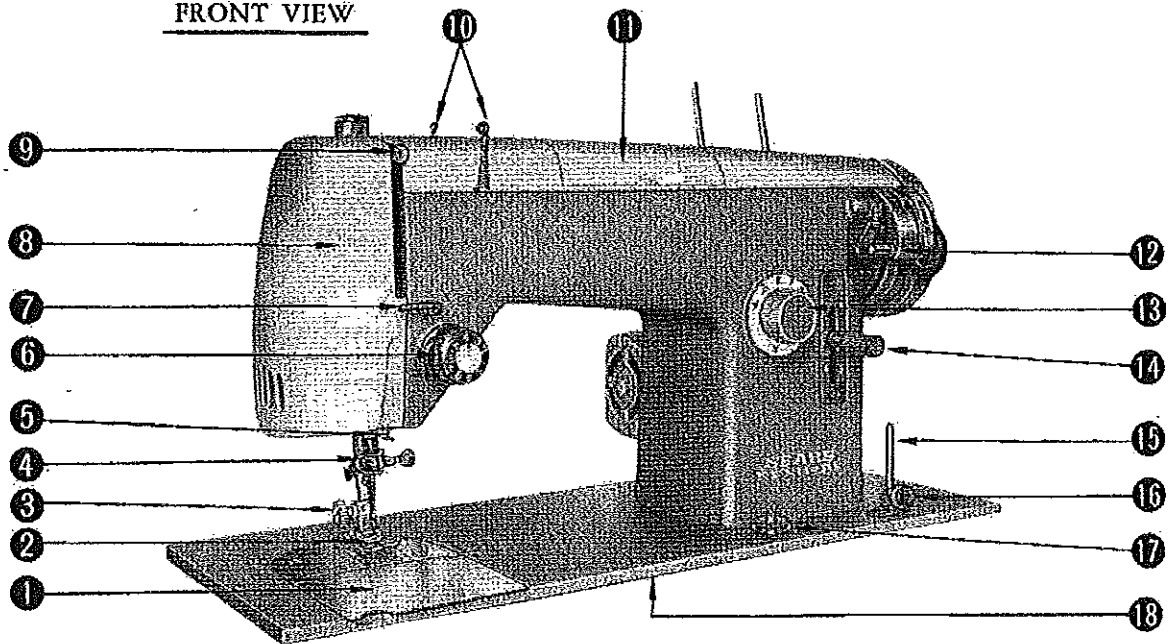

- | | | |
|-----------------------------|--|--|
| 1. Hand Hole Cover plate. | 8. Face Cover Plate. | 13. Stitch Width and Buttonhole Control Knob |
| 2. Presser Foot | 9. Thread Take-up | 14. Stitch Length Control Lever |
| 3. Presser Foot Thumb Screw | 10. Upper Thread Guides | 15. Thread Spool Pin for Bobbin Winder |
| 4. Thread Guide | 11. Cover to Automatic Decorating Stitch Mechanism | 16. Bobbin Winder Tension Disc |
| 5. Thread Guide | 12. Bobbin Winder Assembly | 17. Feed Dog Control Knob |
| 6. Thread Tension Assembly | | 18. Nomenclature Plate |
| 7. Thread Guide. | | |

BACK VIEW

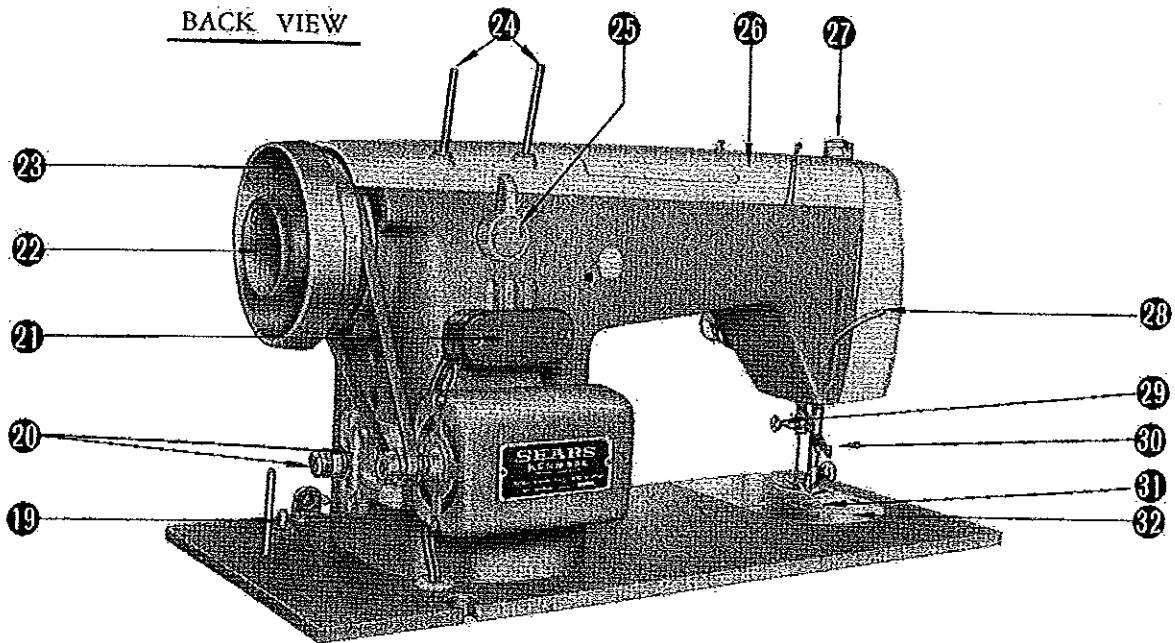

- 19. Light Switch
- 20. Motor Mounting Bracket and Screw
- 21. Three Prong Connector
- 22. Clutch Knob

- 23. Hand Wheel
- 24. Upper Thread Spool Pins
- 25. Buttonhole Reverse Stitch Length Control
- 26. Arm Cover Plate
- 27. Presser Foot Knob

- 28. Presser Foot Lever
- 29. Needle Clamp Screw
- 30. Thread Cutter
- 31. Feed Dogs
- 32. Needle Plate

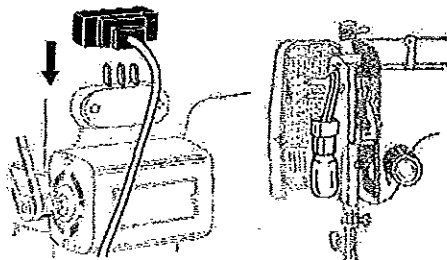
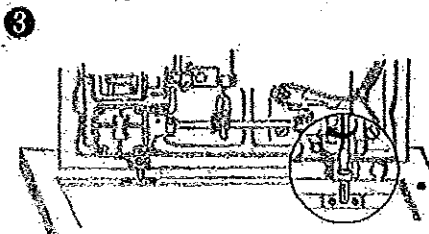
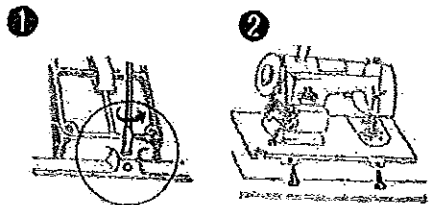

INSTALLING MACHINE HEAD IN PORTABLE AND CABINET

Loosen the two hinge screws under holes in the rear edge of the machine bed (1). Raise hinge pins in the cutout (2). Slip machine head onto the pins and tighten hinge screws securely (3). Lower machine head to front flap.

Lay the plastic discs over the spool pin hole on the arm cover plate. Screw pins in place. Discs and pins are packed in accessory box.

SEWING LIGHT

The sewing light is placed inside the face cover plate as shown. It may be turned on or off by pushing light switch.

To change bulb, open the face cover plate by swinging it open, twist old bulb away from you and remove. Then insert new bulb.

CONNECTING MACHINE

Push the plug onto three prong connector over the machine motor.

Plug machine cord into any 110-120V wall outlet. When installed in cabinet, insert grommet with cord in hole in bedplate.

NEEDLE AND THREAD TABLE

THREAD SIZE	NEEDLE SIZE	FABRIC
Cotton 60-100 Synthetic Silk A Machine embroidery	11	Sheer cottons, silks, and synthetics Fine laces
Cotton 60-80 Mercerized 50 Synthetic Silk A Machine embroidery	14	Medium weight cottons Medium weight silks Medium weight synthetics Light weight woolens
Cotton 40-60 Mercerized 50 Mercerized heavy duty	16	Heavy weight cottons Medium to heavy weight woolens Heavy drapery fabrics
Cotton 30-50 Mercerized heavy duty	18	Heaviest cottons as for men's work clothes Heaviest woolen coating

NEEDLE SIZE

Use **KENMORE 6021** needles. The size of the needle should conform to the size of the thread and both should be suitable to the material. The same size thread should be used in the bobbin as on the upper part of the machine for ordinary sewing. Never use a bent needle nor one with a blunt point.



This is the exact length of the needle to be used in your machine. Comparison with this illustration will determine whether the needle you have is the correct one for your machine.

5

PLACEMENT OF NEEDLE

Raise needle bar to its highest position by turning hand wheel toward you. Loosen needle clamp screw. Hold the needle with flat side away from you. Slip the needle as far as it will go into the needle clamp, and tighten the thumb screw.

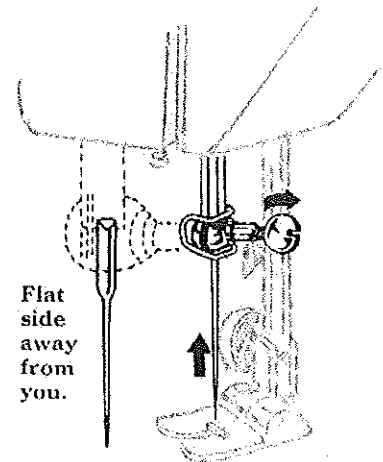

REMOVING BOBBIN CASE FROM SHUTTLE

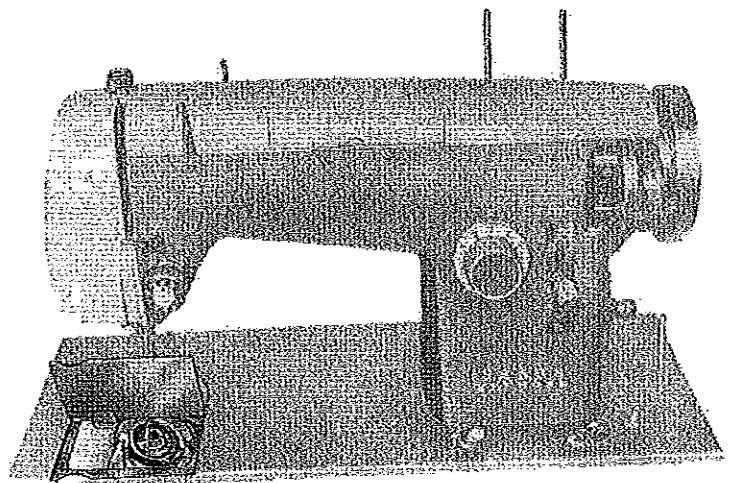
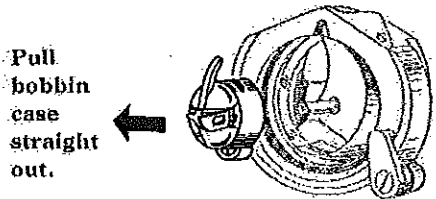
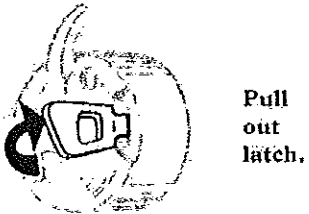
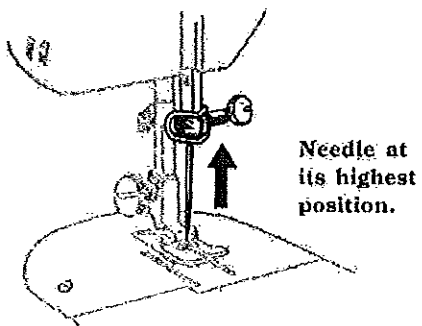

WINDING THE BOBBIN

1

Place thread on the bedplate spool pin. Draw thread to the left behind the bobbin thread guide, through the slot, (see illustration) then from left to right under the bobbin winder thread guide.

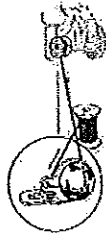

2

Wind thread around bobbin a few times. Place bobbin onto bobbin winder shaft.

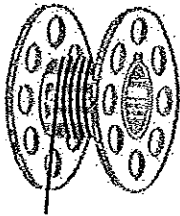

3

Press bobbin winder lever down.

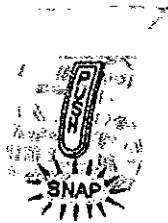

4

Release clutch by turning clutch knob toward you. Start machine. When bobbin is full, winding mechanism stops automatically.

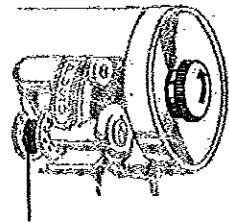

5

Bobbin winder thread guide is adjustable. If bobbin winds as illustrated, slightly move thread guide to an arrow direction to correct this situation.

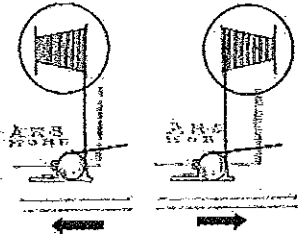

6

Tighten clutch knob and remove bobbin.

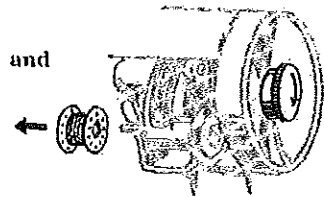

INSERTING BOBBIN INTO BOBBIN CASE.....CASE INTO SHUTTLE

- ① Guide bobbin onto center pin of bobbin case.
- ② Pull thread through slot.
- ③ Pull thread under tension spring.
- ④ Holding latch, position case into shuttle, release latch.

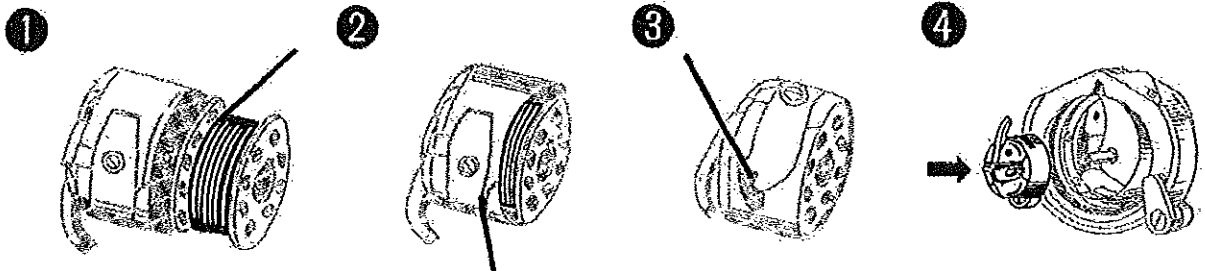

THREADING UPPER MACHINE

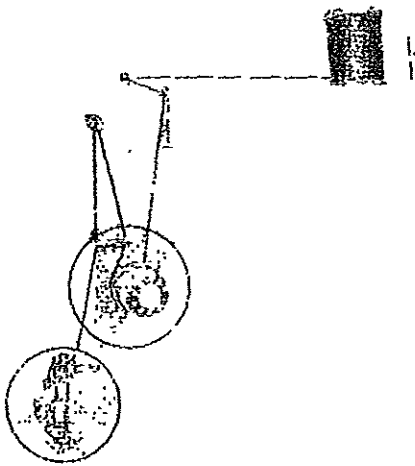

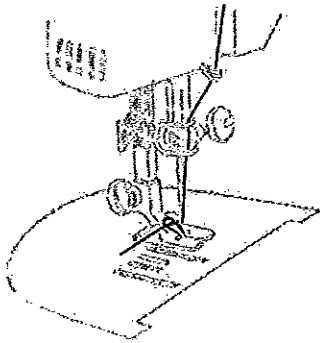

PICKING UP BOBBIN THREAD

Raise presser foot lever.
Hold needle thread loosely in left hand and rotate hand wheel toward you one complete turn.
Bring bobbin thread up by pulling upper thread.
(See illustration).
Place threads back under presser foot.

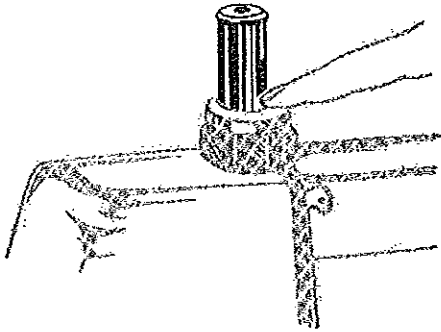

ADJUSTING THE PRESSURE OF THE PRESSER FOOT

Push down outer ring of presser foot knob (See illustration). This will release pressure of presser foot. To increase pressure, push down inner pin until suitable pressure is obtained.

For ordinary sewing, the inner pin should be about half way down. When sewing multiple thickness or heavy material, reduce the pressure. Increase it when sewing sheer fabrics.

Insufficient pressure may cause skipped stitches or difficulty in guiding the fabric. If feed dog or presser foot marks appear on the fabric, reduce the pressure.

SETTING STITCH LENGTH

The stitch regulator lever controls the stitch length. Set lever to any desired stitch length position between 0 and 4 by turning knob clockwise until the knob indicator is aligned with the stitch length number desired. The red mark opposite 5 indicates the setting for a satin stitch. This will vary slightly depending upon the type of material to be sewn. At No. 4 the longest stitch is obtained. The size of stitch you select will depend on fabric you are sewing. To lengthen stitch, turn the knob counter clockwise until the lever can be lowered to the position desired. To straight stitch, stitch width control should be set on 0 setting.

REVERSE STITCHING

Raise lever for reverse stitching. Lower lever for forward stitching. It is best to begin and end most seams with reverse stitching often called back tacking.

BASTING

For accomplishing quicker, more even and firmer basting, we suggest you regulate the machine in the following manner: Set stitch regulator at No. 4 for the longest possible stitch. Basting is easily removed by pulling bottom thread. When basting very sheer fabrics, use a paper backing.

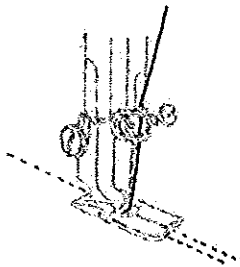

FASTENING A SEAM

Be sure both threads are drawn back under the presser foot. Lower needle into fabric about $\frac{1}{2}$ inch from beginning of seam. Push stitch length control lever up for reverse stitching. Stitch in reverse until needle reaches beginning of seam. Move stitch length control lever down for forward stitching and complete seam. When you reach the end, raise the stitch length control lever and sew back over $\frac{1}{2}$ inch of completed seam.

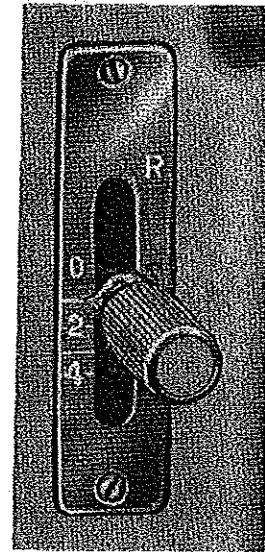

ADJUSTING TENSIONS

1



Fig. 1

A perfect stitch will have threads locked between the two layers of fabric with no loops on top or bottom. (Refer to page 32)

PROBLEM

REMEDY

2

Upper thread too tight



Fig. 2

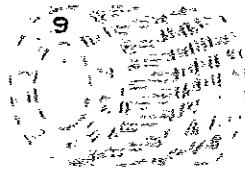

Decrease Tension

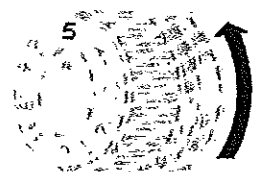

3

Upper thread too loose



Fig. 3

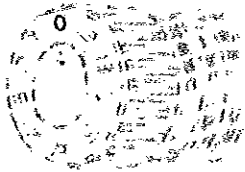

Increase Tension

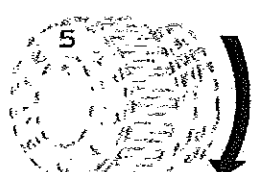

When stitching is unsatisfactory as in figures 2 and 3, adjust the upper thread tension. Lower thread tension requires adjustment less frequently than the upper thread tension.

When stitch is satisfactory, as in figure 1 and seam is badly puckered, the cause may be tight tensions and both upper and lower may be adjusted. (See page 32)

When adjusting the tension on the bobbin case, make slight adjustments with a screwdriver. (See page 32)

INCREASE TENSION

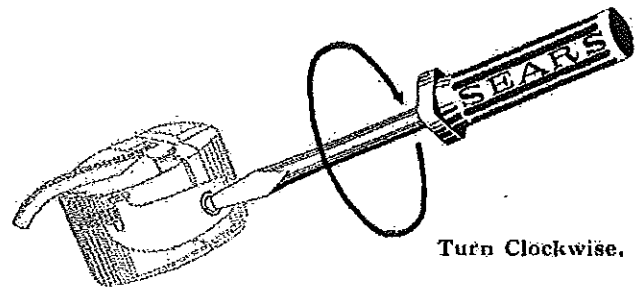

DECREASE TENSION

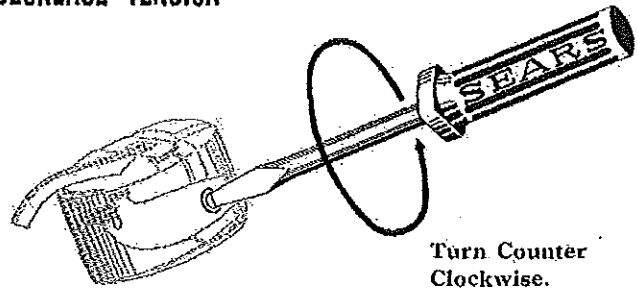

INSERTING AND REMOVING THE MATERIAL

For all kinds of sewing, consult chart page 5.

Before placing the material on the machine see that:

- *The presser foot and needle clamp screws are both tight.
- *The sizes of needle and thread suit the kind of work to be done.
- *The needle and take-up lever are at their highest position.
- *The ends of the threads have been drawn about 4 inches to the rear of the machine.
- *The feed dogs are up.

Place material under the presser foot, insert the needle into the material by turning the hand wheel toward you, lower presser foot and start sewing. Experiment by sewing on the fabric to be used to determine tension adjustment and correct stitch settings.

To remove the work, first turn hand wheel toward you until needle is at its highest position, then raise the presser foot, draw material to the rear and cut off excess thread with the thread cutter located on the presser bar. To avoid sewing off the end of the material, back tack each seam. See page 11.

IMPORTANT; Always turn the hand wheel toward you! When machine is not being used, place a piece of material over the feed dog and lower the presser foot. Always have fabric under the presser foot when operating the machine. Operating thread machine without fabric will cause it to jam by forcing lint into the shuttle. See pages 28 & 29.

CHANGING THE PRESSER FOOT

The various attachment feet available for certain kinds of work are to be fastened to the presser bar.

To attach the foot, raise the presser bar to its highest position by raising the presser foot lever. Loosen the presser foot thumb screw, choose the proper foot, insert from the front. Tighten the screw using the large screw driver and make sure that the foot is secure.

TURNING A CORNER

Stop sewing machine with needle in fabric. Raise presser foot. Turn fabric. Lower presser foot and continue stitching.

FEED DOG CONTROL

The drop feed control knob is situated on the right front of machine bedplate. When knob is turned to the right feed dog drops and does not pull material. This allows the operator freedom of movement of material, as for darning. For regular sewing, turn knob to the left.

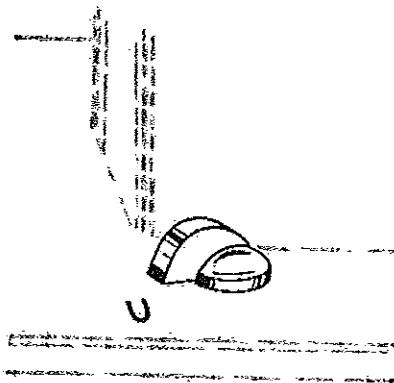
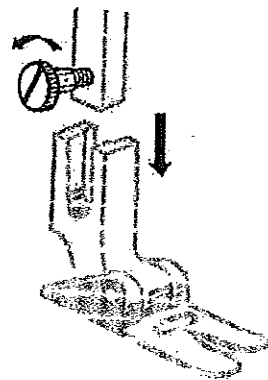

ZIGZAG CONTROL

SETTING STITCH WIDTH

Insert disc #1A. Turn the stitch width knob to the desired setting between 0 and 4 on the knob. Zigzag stitch width increases from 0 to 4. Straight stitching is possible only with control on 0 setting.

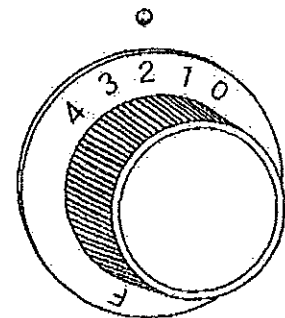

INSERTING PATTERN DISC

1. Pull automatic stitch mechanism cover open.
2. Push cam follower release lever (A) to the right and keep it there during insertion.
3. Grasp pattern disc and slip disc onto the shaft. Make sure the retaining pin (B) enters hole in disc.
4. To remove pattern disc, reverse the above procedure.

There are two different patterns on each disc. A picture of each pattern is on the disc surface. Position disc into machine with desired pattern facing up.

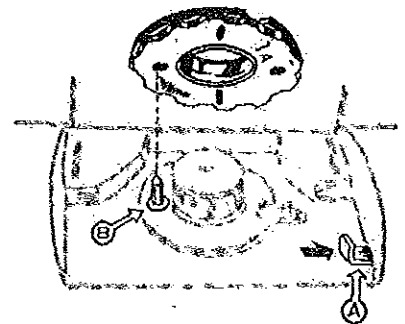

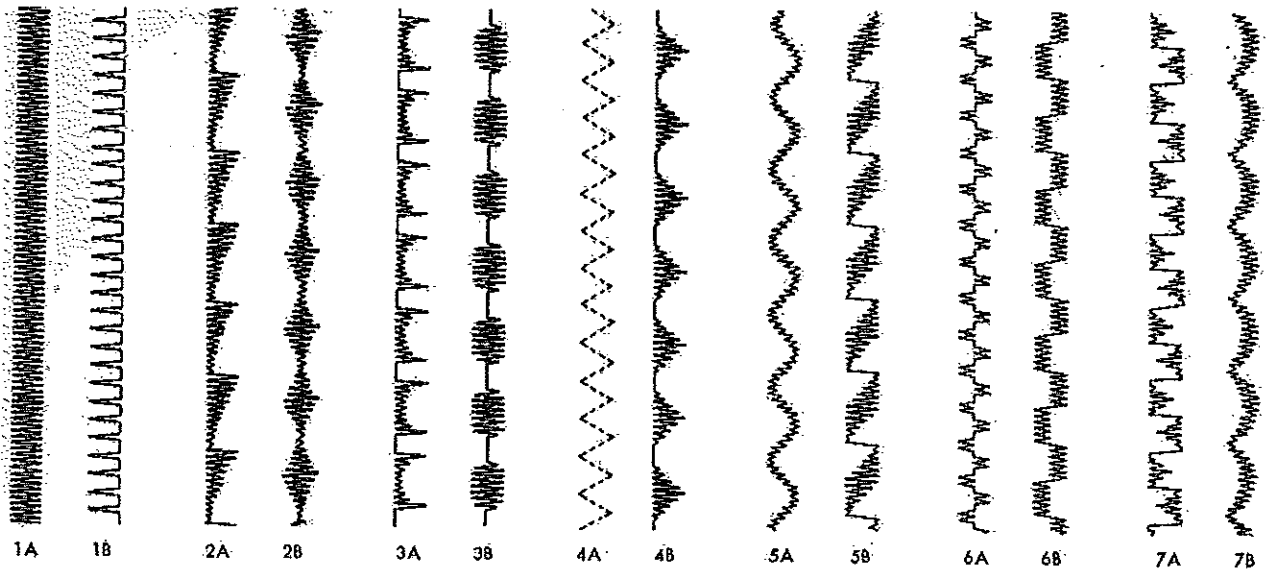

AUTOMATIC DECORATIVE STITCHING

This machine enables you to sew beautiful decorative and embroidery stitches by means of various discs supplied with your machine. The movements of the needle are automatically controlled by the disc. Basic decorative stitches are made with stitch width at 4 and stitch length at the red mark opposite S. The latter will vary slightly depending upon the type of material to be sewn. Pattern will be changed if using any other length or width. All patterns also can be made with double needle. See page 25.

DARNING

WITH PRESSER FOOT :

1. Turn feed dog control to right.
2. Press down outer ring of presser foot knob, see page 10. With presser foot knob in this position, mending, darning, monogram work, etc. may be done.
3. Stretch fabric tightly between two spring embroidery hoops and place under needle.
4. Lower presser bar so thread will have some tension. When you start to darn, move fabric back and forth to cover darning area. Then turn fabric and continue sewing at right angles to the previous stitching. Use medium machine speed. You can make any length stitches desired. Slow movement of fabric will make short darning stitches. Fast movement will make long stitches.
5. When you finish darning, raise presser foot and remove fabric. Increase pressure for general sewing by pressing down inner pin of the presser foot knob. Turn feed dog control to left.

WITHOUT PRESSER FOOT :

1. Turn feed dog control to right.
2. Remove presser foot.
Proceed as directed under steps 3 and 4 above.
5. When you finish darning, raise the presser foot lever and remove fabric. Replace presser foot, and increase pressure for general sewing. Turn feed dog control to left.

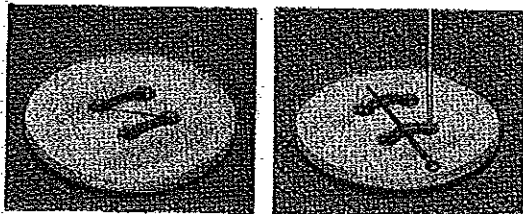

SEWING ON BUTTONS

Use disc #1A

Center holes in button in slit in presser foot. Lower presser foot to hold securely. Drop feed dogs. Turn handwheel by hand until needle goes into hole in button. Adjust stitch width so that needle goes into second hole. Stitch a number of times to hold securely.

NOTE: To make a small thread shank when sewing on a flat button, place a straight pin or needle between the holes of the button.

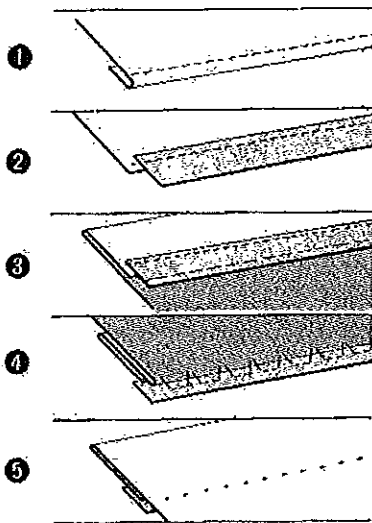

BLIND STITCHING

Disc #1B
Stitch width 4
Stitch length 2-4

1. Prepare the hem with a turned and edgestitched finish or;
2. Apply seam tape along the raw edge with either straight or zigzag stitching.
3. Turn hem and baste about $\frac{1}{8}$ inch from the edge of the seam tape using longest stitch on the sewing machine.
4. Fold garment back along basting line and stitch along garment fold using disc #1B;
5. Remove basting and press hem. The basting step may be eliminated in a straight hem.

BUTTONHOLES

Insert cam 1A, and special buttonhole foot
Stitch length in red zone
Buttonhole control knob F
Feed dogs U

Mark buttonhole length at both ends. Without lowering the foot, let the needle pierce the fabric at the beginning of the buttonhole. The buttonhole length will be the distance between the needle and the front edge of the sliding portion of the foot. Set the front edge of the foot opening with a slight bartack allowance at the mark on the opposite end of buttonhole. Lower the foot. Stitch forward until the needle reaches the red zone on the front edge of foot. Then turn the knob to R, and stitch the other side of the buttonhole. Turn knob back to F to finish end of buttonhole. The speed with which the knob is turned determines the number of stitches at the ends of the buttonhole. The slower the knob is turned, while sewing, the more stitches are formed.

Reproduction on identical size buttonholes is facilitated with the aid of the graduations on the left side of the buttonhole foot. These graduations are 1/8 inch apart. Just mark the starting points of the buttonholes, let the needle pierce the fabric and set the index mark (A) on the upper portion of the foot at the same graduation mark (B) as it was set for the first buttonhole. Lower the foot. Follow the procedures outlined above.

Always make a practice buttonhole on a scrap of fabric used in the garment, using a double thickness of fabric, and an interfacing if used in garment.

The stitch length may be varied. To increase forward stitch lower stitch length lever. The buttonhole reverse stitch length control governs the length of the reverse stitches. Turn the dial to the left for longer stitches; to the right for shorter stitches. These settings may vary depending on type of fabric used.

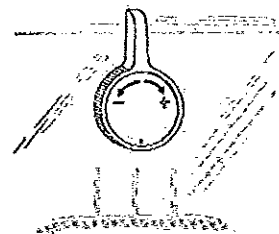
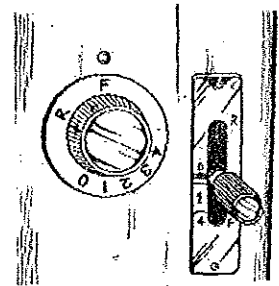
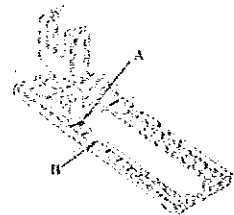

STEP 1

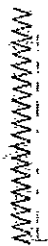
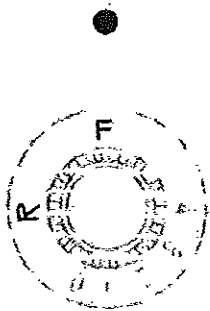

STEP 2

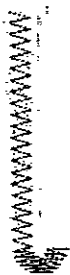
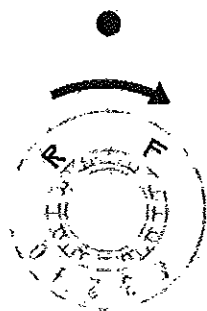

STEP 3

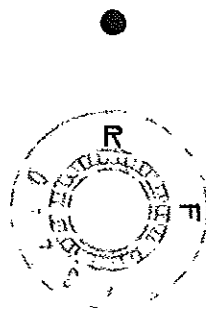

STEP 4

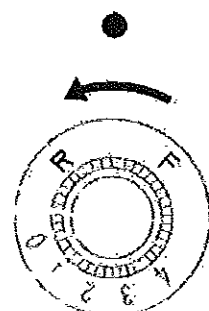

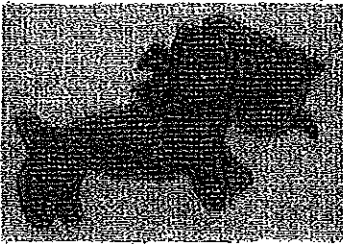

APPLIQUE Use disc #1A

Baste cutout applique to fabric. Set stitch width 2 to 4. Set stitch length at the red mark opposite S. Zigzag stitch around applique completely covering the raw edge.

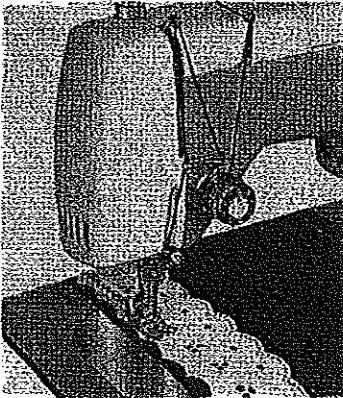

SEWING ON LACE Use disc #1A

Set stitch width to 1. Set stitch length to 1 or 2. Place fabric under the presser foot and place lace on top of fabric overlapping edge by $\frac{1}{4}$ inch. Start sewing with needle at the left stitch. Position fabric and lace so that needle goes into left edge of lace. To sew two pieces together to make a continuous pattern, use the same method.

OVERCASTING

Use disc #1A

Set stitch width to 4. Set stitch length to about 3. Zigzag stitch around raw edge of fabric to completely cover the edge.

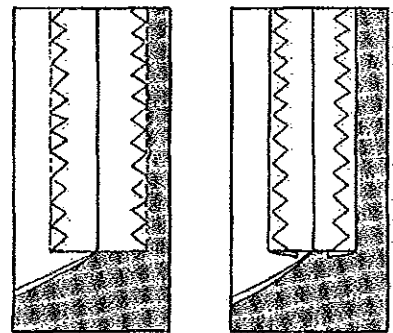

WRITING AND MONOGRAMMING

Use disc #1A

Free hand
Stitch width 0 to 4
Feed dog Right

Draw initials or words to be sewn on fabric and fit fabric into embroidery hoops. Writing is done with either zigzag or straight stitching. Remove presser foot. Set stitch width for straight or zigzag stitches as desired. Slip hoop and fabric under the needle, lower presser bar and take one stitch to raise hobbin thread through fabric. Using a medium speed, stitch along marked outline, guiding fabric carefully by hands.



DOUBLE NEEDLE



SETTING THE DOUBLE NEEDLE

Raise the needle bar to its highest position and loosen needle clamp screw. Hold double needle assembly with flat side away from you. Slip the needle as far as it will go into needle clamp, and tighten the thumb screw.

THREADING THE DOUBLE NEEDLE

Place a spool of thread on each spool pin. Draw both threads through upper thread guides. Continue threading the machine as you would for single needle sewing. Draw one thread through each needle from front to back and pull several inches of thread through. Thread bobbin and pick up bobbin thread as for single needle sewing.

THREAD SELECTION

Use mercerized sewing thread size 50 and finer. Machine embroidery thread is recommended for both upper and lower threading.

DOUBLE NEEDLE

STITCHING

All decorative patterns are possible with double needle. Before starting any stitching operation, check needle drop by turning the handwheel manually. Needle should enter fabric without touching presser foot and needle plate. The stitch width control should not be advanced beyond 3 setting.

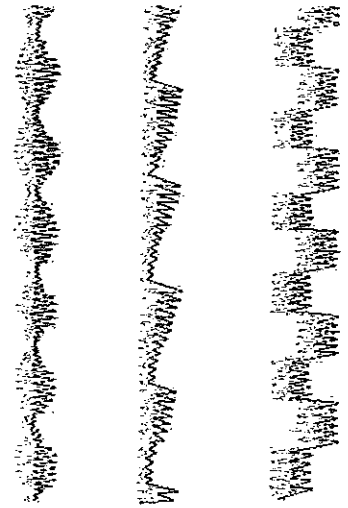

TURNING A CORNER

To turn a square corner in double needle stitching, stop stitching with the needle tips just piercing the fabric. Raise the presser foot, shift fabric half the turn, lower presser foot and take one stitch. Raise the presser foot again, complete the turn, and begin stitching in the new direction.

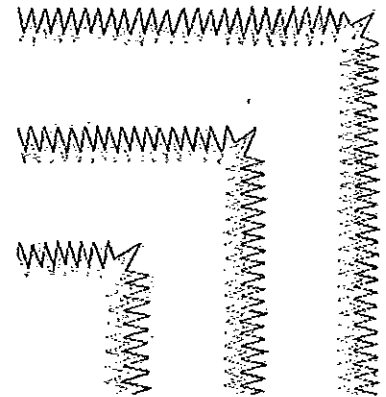

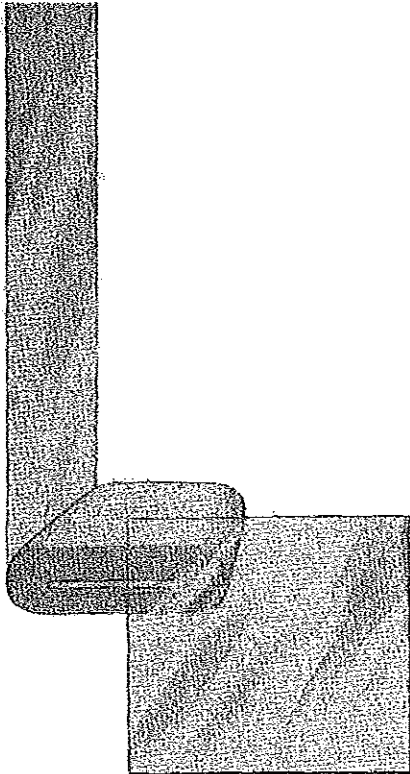

SYNTHETICS

Your KENMORE will sew all the new fabrics of synthetic fiber, such as nylon, *Orlon, **Dacron, rayon, acetate, blends of these, and combinations of synthetic and natural fibers. When stitching a fabric of blended or combined fibers, handle it as you would a material of the fiber present in the largest percentage. For example, a fabric woven of 60% Orlon and 40% silk should be handled as one made entirely of Orlon.

When stitching a fabric that is over 50% synthetic fiber, remember:

- a. Select patterns of the loose fitting type with cap or kimono sleeves, because most synthetic fiber fabrics cannot be eased with steam pressing, and are not absorbent.
- b. Use a synthetic thread.
- c. Use a fine needle as recommended in chart on page 5.
- d. Wind the bobbin in the usual way, but do not pass thread between tension discs. Guide thread by hand for a smoothly wound bobbin.
- e. Choose the stitch length that gives the most satisfactory seam.
- f. Check thread tensions by sewing on a double thickness of the fabric to be used. Usually the upper thread tension must be loosened. Sometimes both bobbin and upper thread tensions must be loosened (page 12, 13).

SEWING ON PLASTIC FILMS

Set the machine with normal thread tensions and a large size stitch. Use a fine needle and mercerized thread. Hold plastic pieces together with cellophane tape or paper clips rather than pins. Sew corners slightly rounded rather than square.

*Trademark for Dupont's Acrylle fiber. **Trademark for Dupont's polyester fiber.

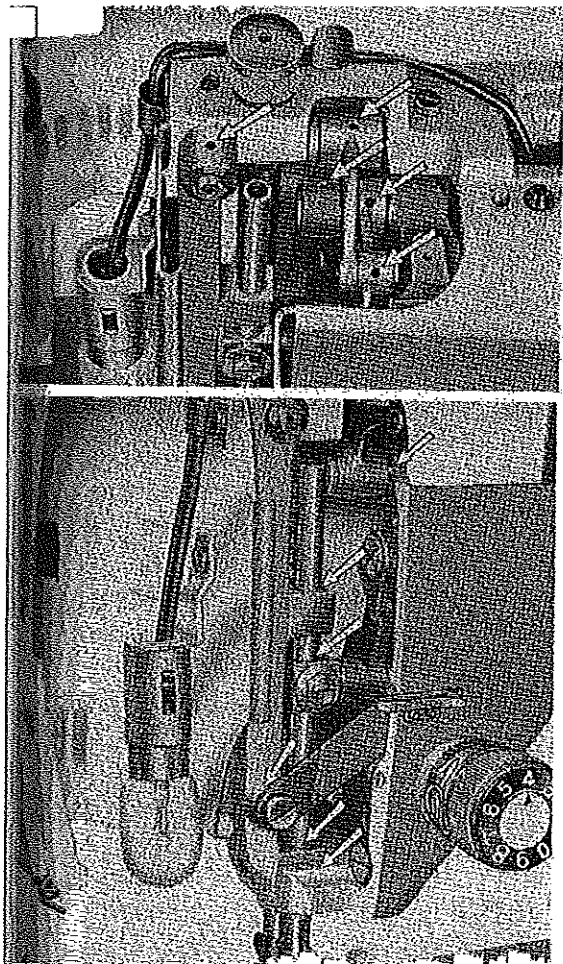

Fig. A

REPLACEMENT OF THE BELT

To replace a worn belt, loosen motor bracket set bolt and remove belt by reducing the distance between motor pulley and hand wheel. Install new belt and adjust the distance between the motor pulley and hand wheel. To provide proper tension, allow the belt to support the weight of the motor and then firmly tighten the motor bracket set bolt.

CLEANING AND OILING.....

Keep the moving parts free from dust and threads for quiet and efficient operation. Cleaning should be done with a small brush.

When machine runs hard or makes excessive noise, place a drop of KENMORE sewing machine oil at the points indicated in figs. A, B, & C.

Swing hinged face cover plate open to oil points indicated at end of machine head.

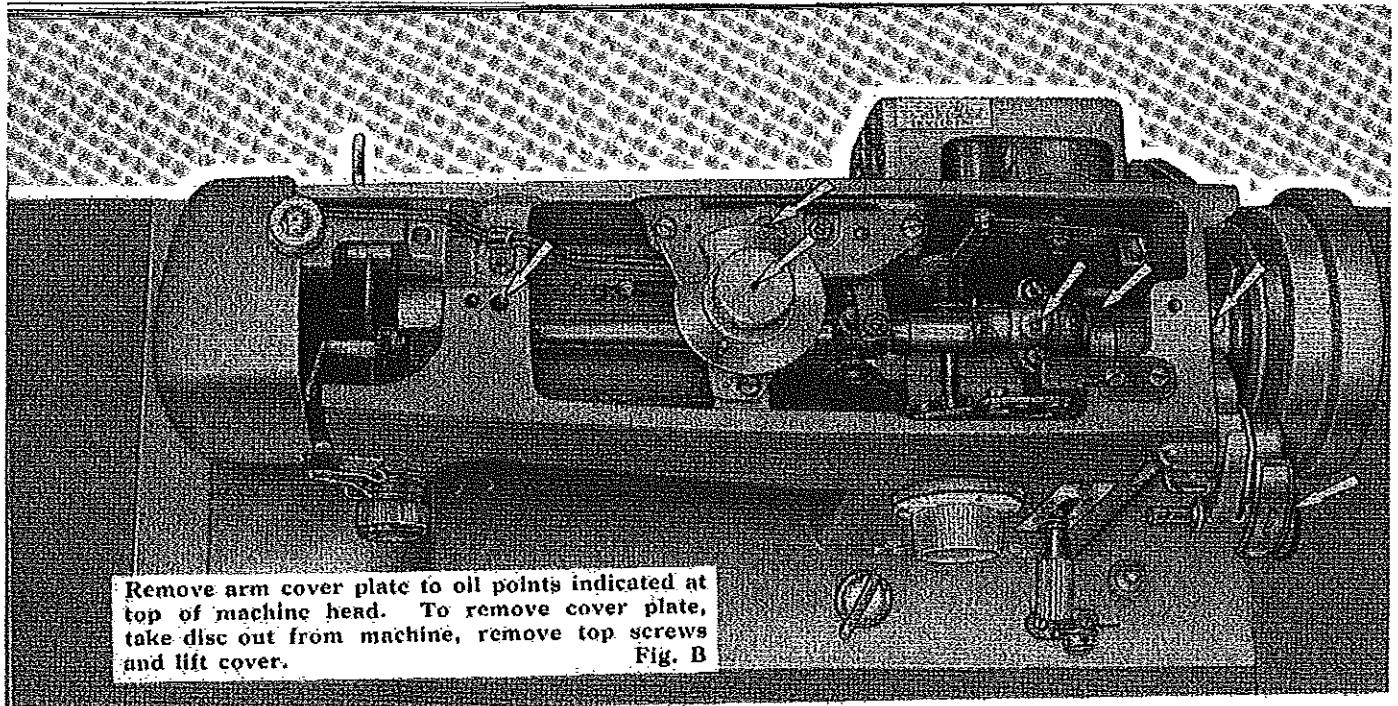

It may be necessary to clean the shuttle area occasionally.

1. Raise the needle bar to its highest point and remove bobbin case.
2. Push levers sideways of the shuttle assembly and lift hook and hook ring out by the center pin.
3. Clean the shuttle race of any lint or small particles of thread with a small brush.
4. Put a drop of oil on the center pin and on race in back of the hook.

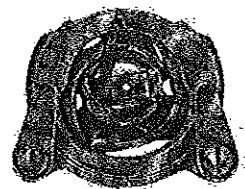

Shuttle Assembly

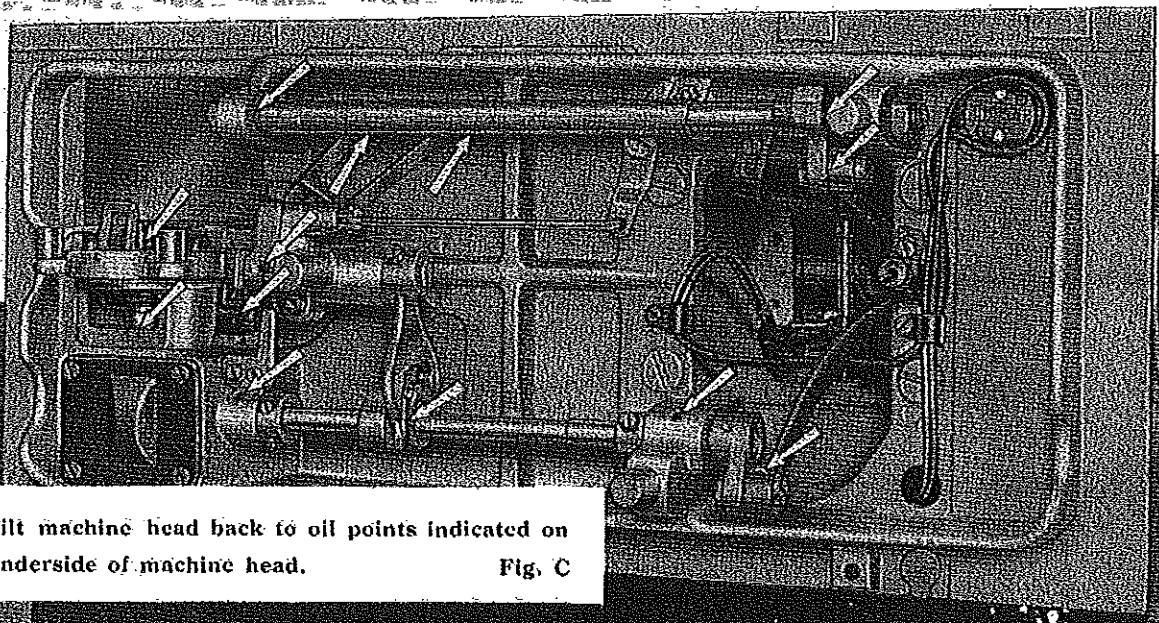

Tilt machine head back to oil points indicated on underside of machine head. Fig. C

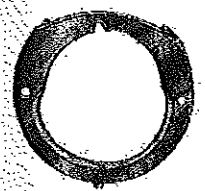

Hook Ring



Hook

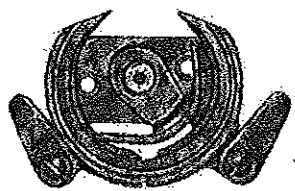

Hook Race

To reassemble, hold hook by center pin and fit carefully into assembly opposite the hook driver. Slip hook ring into place. Snap the lever into position. Occasionally, remove the needle plate and clean feed dog with a soft brush.

WHAT TO DO

PROBLEM	PROBABLE CAUSE	CORRECTION
Irregular Stitches	Incorrect size needle. Improper threading. Loose upper thread tension. Pulling fabric. Light pressure on presser foot. Loose presser foot. Unevenly wound bobbin.	Choose correct size needle for thread and fabric (page 5). Rethread machine (page 9). Tighten upper thread tension (page 12). Do not pull fabric; guide it gently. Increase pressure on presser foot (page 10). Reset presser foot (page 15). Rewind bobbin (page 7).
Breaking Needles	Pulling fabric. Incorrect size needle. Incorrect setting of needle. Loose presser foot.	Do not pull fabric; guide it gently. Choose correct size needle for thread and fabric (page 5). Reset needle (page 5). Reset presser foot (page 15).
Bunching of Thread	Upper and lower threads not drawn back under presser foot. Feed dog down.	Draw both threads back under presser foot (page 10). Raise feed dog (page 15).
Puckering	Incorrect thread tension(s). Light pressure on presser foot. Using two different sizes or kinds of thread. Bent or blunt needle. Loose presser foot. Fabric too sheer or too soft.	Reset thread tension(s) (pages 12, 13). Increase pressure on presser foot (page 10). Upper thread and bobbin thread should be same size and kind. Insert new needle (page 5). Reset presser foot (page 15). Use underlay of tissue paper or tarleton when stitching.

WHAT TO DO

PROBLEM	PROBABLE CAUSE	CORRECTION
Skipping Stitches	Incorrect size needle. Bent or blunt needle. Incorrect setting of needle. Tight upper thread tension. Light pressure on presser foot.	Choose correct size needle for thread and fabric (page 5). Insert new needle (page 5). Reset needle (page 5). Loosen upper thread tension (page 12). Increase pressure on presser foot (page 10).
Breaking Upper Thread	Starting to stitch too fast. Improper threading. Tight upper thread tension. Incorrect size needle. Sharp eye in needle.	Start to stitch at a medium speed. Rethread machine (page 9). Loosen upper thread tension (page 12). Choose correct size needle for thread and fabric (page 5). Insert new needle (page 5).
Breaking Bobbin Thread	Improper bobbin case threading. Tight bobbin thread tension. Lint in bobbin case or shuttle.	Check bobbin case threading (page 8). Loosen bobbin thread tension (page 13). Clean bobbin case and shuttle (pages 28, 29).
Fabric not Moving	Feed dog down. Light pressure on presser foot. Threads knotted under fabric.	Raise feed dog (page 15). Increase pressure on presser foot (page 10). Place both threads back under presser foot before beginning to stitch.
Machine Jamming (Knocking Noise)	Thread caught in shuttle.	Disassemble and clean shuttle (pages 28, 29).

ADJUSTING YOUR SEWING MACHINE FOR GOOD STITCHES

When your sewing machine does not sew a properly locked stitch, check the following:

1. Insert a new needle of the correct size for the thread and fabric you are using. Consult chart on page 5 for needle size.
2. The upper and bobbin thread should be matched in size and type.
3. Check threading carefully. See page 9.
4. Check the thread tension balance. Use mercerized thread, and a correct size needle for the fabric you are using. Do not try this test with synthetic thread as it will not break.

Begin with a full bobbin, properly threaded into the case. Set the stitch length at about 12 stitches per inch. Fold a 6" square of your fabric in half diagonally, forming a triangle. Make a line of stitching $\frac{1}{2}$ " from fold.

- a. If seam is puckered - both tensions are too tight.
- b. If bottom thread is looped - tighten upper thread tension, and repeat test.
- c. If top thread lays on top of fabric - loosen upper thread tension, and repeat test.

Grasp the stitching and pull with a snap to make threads break.

- a. If both threads break - tensions are balanced.
- b. If neither thread breaks - both tensions are too loose.
- c. If upper thread breaks - loosen upper tension.
- d. If lower thread breaks - tighten upper tension.

Both threads do not have to break at the same place, but they should break on the same snap.

Bobbin tension may also be reset by this procedure. Start with a loose bobbin thread tension. Tighten the spring screw gradually until bobbin case and full bobbin can be gently lifted from your hand by the end of the bobbin thread.

PARTS LIST

All parts listed here may be ordered through your nearest Sears or Simpsons-Sears retail store, catalog sales office or mail order house.

When ordering these parts, please be sure to mention the following references:

1. Model & serial numbers of machine shown on the nomenclature plate. See page 2.
2. Parts number(s) and description(s) here.

When ordering by mail, prices will be furnished on request, or parts will be shipped at prevailing prices and you will be billed accordingly.

Ref. #	Parts #	Description
1	51	Shuttle hook
2	8524	Needle clamp
3	60502 60860	Bobbin Plastic bobbin box with 10 bobbins (60502)
4	8541	Bobbin case
5	3816	Light bulb
6	6021	Needle
7	6026	Double needle
8	1939	Bobbin winder rubber ring
9	2279	Nylon disc
10	8286	Thread spool pin
11	1114 1102 1103 1119 1105 1106 1107	Pattern disc #1A & B Pattern disc #2A & B Pattern disc #3A & B Pattern disc #4A & B Pattern disc #5A & B Pattern disc #6A & B Pattern disc #7A & B
12	1944	Bobbin winder thread guide
13	8522	Presser foot
14	135	Presser foot thumb screw
15	60902	Motor rubber ball
16	9184	Needle threader



WHEN YOU SELECT **K E N M O R E**

A great name in sewing machines you are assured a complete
and continuing service no matter when you may need it

With

**GENUINE SEARS PARTS
FACTORY APPROVED METHODS
EXPERTLY TRAINED MEN**

To continue the value of your purchase
JUST PHONE · WRITE · OR WIRE

Your nearest Sears, Simpsons-Sears,
**RETAIL STORE · CATALOG SALES OFFICE
OR MAIL ORDER HOUSE**

Please be sure to mention the number shown on your
nomenclature plate. See page 2.

**SEARS, ROEBUCK AND CO. and
SIMPSONS-SEARS-LIMITED**